

# Barras de refuerzo y pinzas para fijos

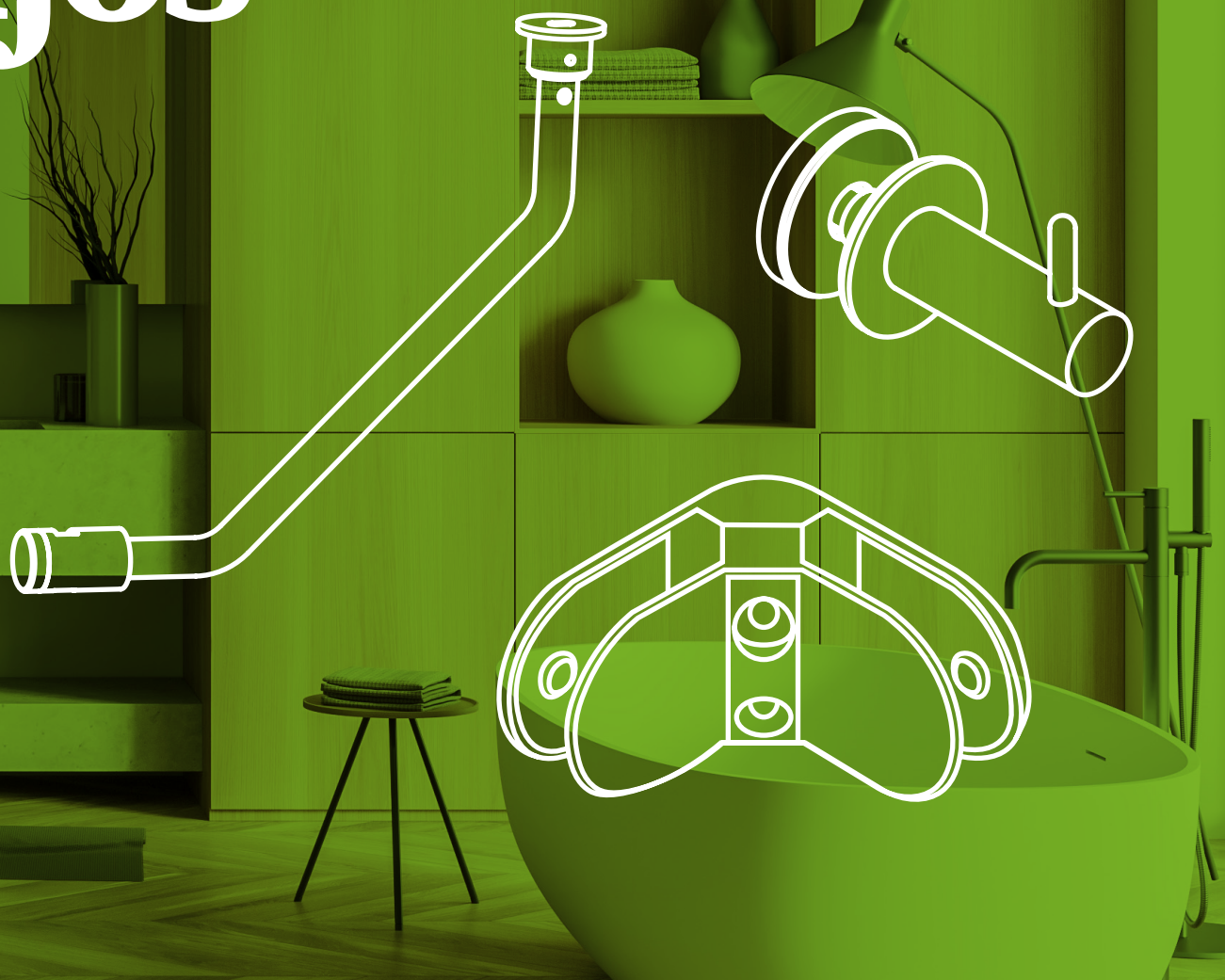

8.1 - KITS.....	88
8.2 - COMPONENTES .....	89
8.3 - PINZAS DE FIJACIÓN .....	90



## 8.1 - KITS

Vidrio 6/10 mm

AISI-304

### BARRA EXTENSIBLE VIDRIO/PARED 45°

De 270 a 450 mm

#### Acabados:

Inox brillo	<b>7683 IB</b>
Inox mate	<b>7683 IM</b>
Negro mate	<b>7683 NE</b>

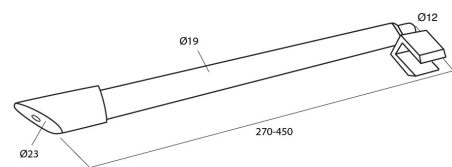

### BARRA EXTENSIBLE VIDRIO/PARED

De 800 a 1000 mm

#### Acabados:

Inox brillo	<b>7684 IB</b>
Inox mate	<b>7684 IM</b>
Negro mate	<b>7684 NE</b>

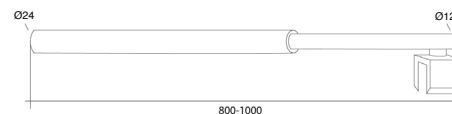

### BARRA EXTENSIBLE CUADRADA

De 800 a 1000 mm

#### Acabados:

Inox brillo	<b>7686 IB</b>
Inox mate	<b>7686 IM</b>
Negro mate	<b>7686 NE</b>

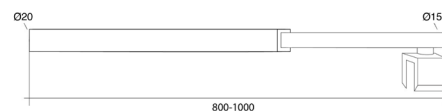

SERIE SVELT

Vidrio 8/10 mm

AISI-304

**BARRA ESTABILIZADORA FIJA 90°**

2 puntos de fijación a pared

L: 2500 mm

**Acabados:**

Distancia de fijación: 150 mm

Derecha	Inox brillo	<b>1925.60D IB</b>
	Inox mate	<b>1925.60D IM</b>
	Negro mate	<b>1925.60D NE</b>

Izquierda	Inox brillo	<b>1925.60I IB</b>
	Inox mate	<b>1925.60I IM</b>
	Negro mate	<b>1925.60I NE</b>

Distancia de fijación: 250 mm

Derecha	Inox brillo	<b>1925.61D IB</b>
	Inox mate	<b>1925.61D IM</b>
	Negro mate	<b>1925.61D NE</b>

Izquierda	Inox brillo	<b>1925.61I IB</b>
	Inox mate	<b>1925.61I IM</b>
	Negro mate	<b>1925.61I NE</b>

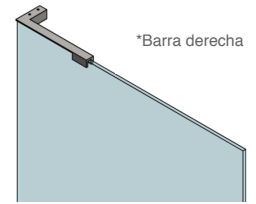
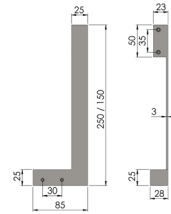
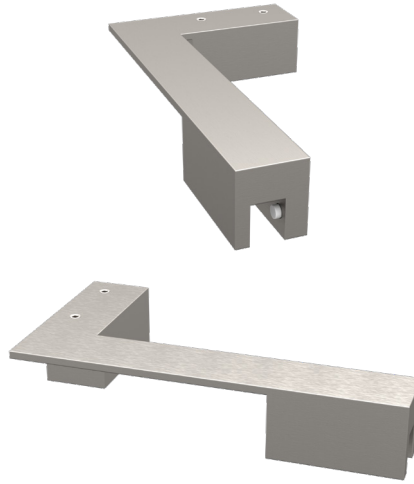

3101  
3102

**BARRA ESTABILIZADORA REGULABLE**

2 puntos de fijación a pared

Ángulo regulable

**Acabados:**

Distancia de fijación: 150 mm

Derecha	Inox brillo	<b>1925.60RD IB</b>
	Inox mate	<b>1925.60RD IM</b>
	Negro mate	<b>1925.60RD NE</b>

Izquierda	Inox brillo	<b>1925.60RI IB</b>
	Inox mate	<b>1925.60RI IM</b>
	Negro mate	<b>1925.60RI NE</b>

Distancia de fijación: 250 mm

Derecha	Inox brillo	<b>1925.61RD IB</b>
	Inox mate	<b>1925.61RD IM</b>
	Negro mate	<b>1925.61RD NE</b>

Izquierda	Inox brillo	<b>1925.61RI IB</b>
	Inox mate	<b>1925.61RI IM</b>
	Negro mate	<b>1925.61RI NE</b>

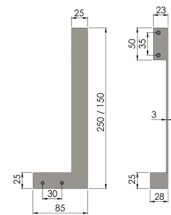
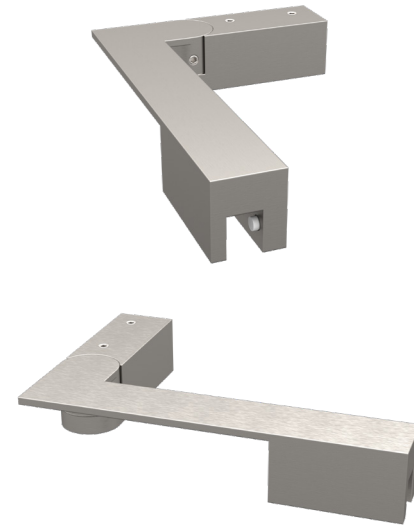

3103  
3104

**BARRA ESTABILIZADORA HORIZONTAL PARED-VIDRIO**

Extremo vidrio giratorio

L=1200 mm

**Acabados:**

Inox brillo	<b>1925.62 IB</b>
Inox mate	<b>1925.62 IM</b>
Negro mate	<b>1925.62 NE</b>

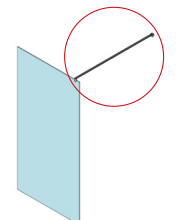
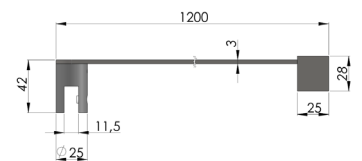
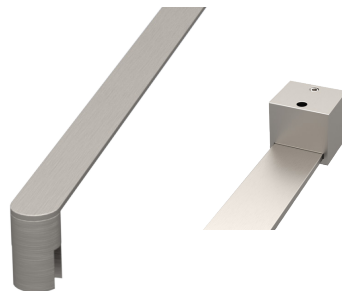

3105



## 8.2 - COMPONENTES

TUBO REDONDO Ø 19 mm

Vidrio 6/8/10 mm

AISI-304

### TUBO INOX Ø 19 mm

Inox brillo

Acabados:

L. 1000 mm	<b>7680.1 IB</b>
L. 1500 mm	<b>7680.2 IB</b>
L. 2000 mm	<b>7680.3 IB</b>
L. 3000 mm	<b>7680.4 IB</b>



### SOPORTE PARED

Acabados:

Inox brillo	<b>7681.1 IB</b>
-------------	------------------

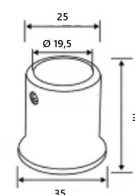

### SOPORTE VIDRIO

Acabados:

Inox brillo	<b>7681.2 IB</b>
-------------	------------------

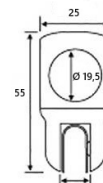

### SOPORTE VIDRIO CIEGO

Acabados:

Inox brillo	<b>7681.3 IB</b>
-------------	------------------

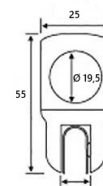

### EXTREMO VIDRIO

Acabados:

Inox brillo	<b>7681.6 IB</b>
-------------	------------------



### SOPORTE PARED 45°

Acabados:

Inox brillo	<b>7682.2 IB</b>
-------------	------------------



INOX

Vidrio 8/10/12 mm

AISI-316

### PINZA SIN MUESCA

45 x 45 mm

Acabados:

Inox brillo	<b>7725 IB</b>
Inox mate	<b>7725 IM</b>

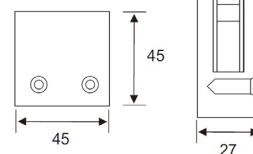

### PINZA SIN MUESCA

50 x 40 mm

Acabados:

Inox brillo	<b>7726 IB</b>
Inox mate	<b>7726 IM</b>

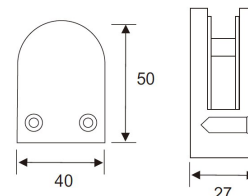

LATÓN

Vidrio 8/10 mm

### PINZA DE FIJACIÓN MAMPARA BAÑO

45 x 45 mm

Acabados:

Plata brillo	<b>7886.1 PB</b>
--------------	------------------

